



Overview

The USBHub3c is a 6-port software-programmable USB 3.2 (Gen2x1; 10 Gbps) hub designed for demanding industrial environments where advanced control and monitoring of USB ports is required. It is ideal for testing or development environments where standard “always-on” behavior of a consumer-grade USB hub is not desirable.

Software control of the USBHub3c is established and maintained over an upstream-facing host port or via a dedicated Control Port connection. Upstream facing host ports can be changed via software control to any USB-C channel (0-6) by Acroname’s AnyPort™ technology.

The USBHub3c can be used to enable and disable individual USB ports, measure voltage and current on USB ports, set programmable current limits, set USB charging protocol behavior, and otherwise automate USB port behaviors in development and testing.

USB Power Delivery (PD) with full 100W support is implemented on every USB-C port of the PRO edition. The PD profiles for each port can be observed and manipulated through software API, enabling extensive testing of other USB devices that support PD, including power sources and sinks.

Qualcomm Quick Charge® is supported on the PRO edition USB-C ports 0-6 and can be enabled through software control.

Typical applications include:

- Power Delivery validation and development
- Phone Compatibility Labs
- USB-C cable validation
- USB device manufacturing
- USB device validation and development
- Plug/unplug cycle testing
- Functional testing

- Battery charging
- USB device resets
- USB power monitoring
- Controlling USB device enumeration sequence

Features

- Supports USB hosts and devices up to USB 3 10Gbps
- Individually enable or disable each USB-C port
- Measure voltage and current on each port’s V_{bus}
- Measure voltage and current on each port’s V_{conn}
- Independently enable or disable Hi-Speed data, SuperSpeed data or V_{bus} lines on each port
- Set programmable current limits for each port, up to 5A on PRO Edition or 3A on LAB Edition
- Dedicated Control Port for software control, independent of the selected upstream port
- Programmable selection of active upstream-facing port from among ports 0-6
- All ports support USB link speeds up to 10Gbps
- Detect established link speed on each port: SuperSpeed (10Gbps, 5Gbps) or Hi-Speed (480Mbps)
- Selectively enable USB charging mode behaviors: SDP (Standard Downstream Port) or CDP (Charging Downstream Port) modes¹
- Deliver up to 100W per port on PRO edition
- Deliver up to 15W per port on LAB edition
- Set enumeration delay for discovery of attached downstream devices
- Backward compatible with USB 2.0 and USB 1.x devices
- DIN-rail mountable
- Euro-style terminal block power input connector
- Certified to +/-15kV ESD strikes (IEC61000-4-2 level 4)
- Overvoltage and reverse current protected V_{bus} outputs

Description

The USBHub3c gives engineers advanced flexibility and configurability over USB ports in testing and development applications.

Each USB-C port implements separate and independently switched USB2/3 data lines, CC, V_{conn} and current-limited V_{bus} lines. USB power, data and SS data can be independently disconnected for advanced USB testing applications. Pin interfaces are protected against reverse polarity and overvoltage.

¹ See http://www.usb.org/developers/docs/devclass_docs/ under the category Battery Charging for full details.

Each USBHub3c is uniquely addressable and controllable from a host PC via the selected USB host input or through a dedicated Control Port. Acroname's BrainStem™ link is then

established over the USB input and allows a connection to the on-board controller in the USBHub3c. USBHub3c can be controlled via a host running BrainStem APIs.

Absolute Maximum Ratings²

Stresses beyond those listed under ABSOLUTE MAXIMUM RATINGS can cause permanent damage to the device. These are stress ratings only and functional operation of the device at these or any other conditions beyond those indicated under RECOMMENDED OPERATING CONDITIONS is not implied. Exposure to absolute-maximum rated conditions for extended periods affects device reliability and may permanently damage the device.

Parameter	Edition	Minimum	Maximum	Units
Input Voltage, V_{supply}		0.0	60.0	V_{DC}
Input Current, I_{supply} ³			27	A _{DC}
Input Power	PRO		500	W
	LAB		100	W
V_{bus} Output Power per USB-C Port	PRO		100	W
	LAB		15	W
Voltage on any V_{bus}		0.0	25	V
Current on any V_{bus}		-5	5	A
Voltage on any USB D+/D-		-0.3	3.6	V
Voltage on CC1 and CC2		-0.3	6	V
Altitude			2000	M
Overvoltage			Overvoltage Category II	

Table 1: Absolute Maximum Ratings

Handling Ratings

Parameter	Conditions/Notes	Minimum	Typical	Maximum	Units
Ambient Operating Temperature, T_A	Non-Condensing	0.0	25.0	50.0	°C
Relative Humidity Range	Non-Condensing	5	-	95	%RH
Storage Temperature, T_{STG}		-10.0	-	85.0	°C
Mass		-	392	-	gm
Electrostatic Discharge, V_{ESD} Meets IEC 61000-4-2, level 4	Air-discharge	-16	-	16	kV
	Contact-discharge	-8	-	8	kV

Table 2: Handling Ratings

Recommended Operating Ratings

Specifications are valid at 25°C unless otherwise noted. Intended for indoor use only.

Parameter	Conditions/Notes	Minimum	Typical	Maximum	Units
Input Voltage, V_{supply} ⁴		6	24.0	48.0	V_{DC}
USB V_{bus} on ports	Hub powered; Port power enabled	3.1	5.0	21.0	V
Relative Humidity Range	Non-Condensing	5	-	80	%RH

Table 3: Recommended Operating Ratings

² If the equipment is used in a manner not specified by the manufacturer, the protection provided by the equipment may be impaired.

³ Input current consumption greater than 16A requires the use of two positive terminals and two negative terminals on the input connector with recommended minimum 14AWG wiring.

⁴ DC power input supplies are required to be limited in power output to specified value and thermally limited for safety. The supply must be approved (IEC/UL/EN 62368 or IEC/UL/EN 60950) with output power limiting.

System Block Diagram

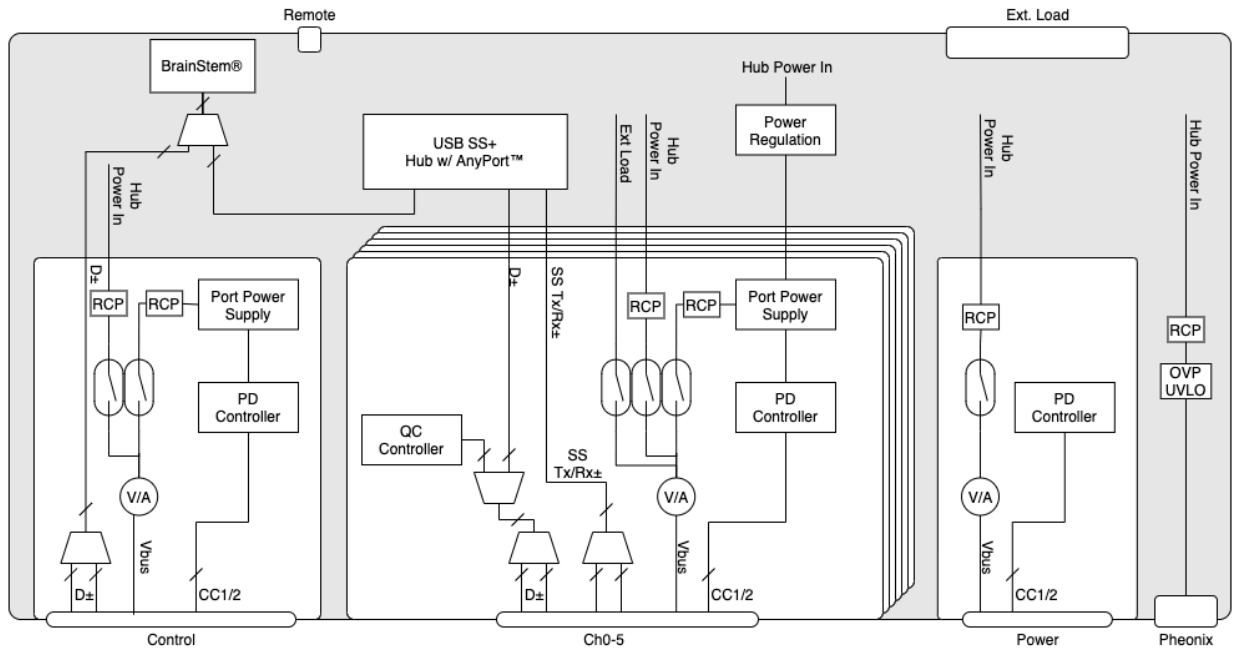

Figure 1: USBHub3c Block Diagram

Editions

The key distinctions between the two hardware editions of the USBHub3c are in Table 4.

Feature	Edition	
	Pro	Lab
USB BC 1.2 Support ^[5,6]	Yes	
USB Power Delivery	2, 3	
Source Capabilities ⁵	3.1 - 20V up to 5A	Fixed 5V up to 3A
Sink Capabilities	3.1 - 20V 0 - 5A	
APDO PPS Variable Voltage Source	Yes	No
APDO PPS Variable Voltage Sink	Yes	
Qualcomm Quick Charge	2, 3, 4, 5	None
PD Source Power Rule (PDO) Editing	Yes	No
External Load Outputs	Software Option Available	
V _{bus} Validation	Software Option Available	
USB-PD Logging	Software Option Available	
NIST Traceability Certificate	Software Option Available	

⁵ Not available on Power-C Type-C port

⁶ Not available on Control Type-C port

Table 4: Configuration options for the USBHub3c

Typical Performance

System Characteristics

Specifications are valid at 25°C unless otherwise noted. Indoor use only. Sample rates are typically limited by the USB throughput of the host operating system.

Parameter	Conditions/Notes	Min	Typ.	Max	Units
Input Power, W_{supply} , no downstream devices attached		-	0.3	-	W
V_{supply} Under Voltage Lockout (UVLO)		-	5.0	-	V
V_{supply} Over Voltage Lockout (OVLO)		52.8	56.1	60	V
Wide Input Range System Efficiency	At 24.0V input, nominal 240W load ⁷	88	-	90.5	%
System Input current Type-C port, I_{vbus}	Dependent upon USB-C supply and Load	100	-	5000	mA
Input voltage measurement range		0	-	64	V
Input voltage measurement resolution, V_{supply}	Euro-style connector only	-	1	-	mV
V_{supply} voltage measurement accuracy		-1	-	1	%FSR
Measurement Sampling Rate			100		Hz

Table 5: Typical Performance Characteristics

⁷ Representative load based on 6 USB downstream devices running in power delivery mode consuming approximately 40W each.

USB-C Port Characteristics

Specifications are valid at 25°C unless otherwise noted. Indoor use only.

Parameter	Conditions/Notes	Min	Typ.	Max	Units
V _{bus} Source Power ⁸	PRO Edition	-	-	100	W
	LAB Edition	-	-	15	W
Output Voltage, V _{bus}	PRO Edition	2.8	5.0	21.0	V
	LAB Edition	-	5.1	-	V
V _{bus} Voltage Measurement Full Scale Range		0		32	V
V _{bus} Voltage Measurement Resolution		-	488	-	μV
V _{bus} Voltage Measurement Accuracy		-0.5	-	0.5	%FSR
V _{bus} Voltage Setpoint Resolution		-	4.2	-	mV
V _{bus} Voltage Ripple	Peak to peak at target V _{bus} voltage	-	-	15	mV
V _{bus} Current Setpoint Resolution	PRO Edition	-	25.8	-	mA
	LAB Edition	-	16.3	-	mA
V _{bus} Current Measurement Full Scale Range		-10	-	10	A
V _{bus} Current Measurement Resolution		-	300	-	μA
V _{bus} Current Measurement Accuracy		-0.5	-	0.5	%FSR
USB SuperSpeed Data Rate	May depend on host or devices	-	-	10	Gbps
USB Hi-Speed Data Rate	May depend on host or devices	-	-	480	Mbps
V _{bus} Current Supply (SDP mode)	USB 2.0 data lines disabled or no USB host present, device limited	-	100	-	mA
V _{bus} Current Supply (SDP mode)	USB 2.0 data lines enabled and USB host present, device limited	-	500	-	mA
V _{bus} Current Supply (CDP mode)	USB 2.0 data lines enabled, USB host present, device limited	-	1500	-	mA
V _{bus} Current Supply (DCP mode)	USB 2.0 data lines enabled, no USB host present, device limited	-	5000	-	mA
V _{conn} Output Voltage, V _{conn}		4.0	5.0	5.5	V
V _{conn} Output Voltage Ripple	Peak to Peak	-	-	132	mV
V _{conn} Current Output		-	-	400	mA
V _{conn} Line Capacitance		-	115	-	pF
USB D± Voltage High Level		2.475	-	3.3	V
USB D± Voltage Low Level		0	-	0.6	V

Table 6: Operating specifications

⁸ Power-C port only capable of Power Delivery Sink operations on V_{bus}

Expansion Interface Characteristics

Specifications are valid at 25°C unless otherwise noted. Indoor use only.

Parameter	Conditions/Notes	Min	Typ.	Max	Units
External Rail 0-5 Voltage		0.0	-	26.7	V
External Rail 0-5 Current		0.0	-	5.0	A
External Rail 6 Voltage	PRO Edition	4.0	5.0	5.5	V
	LAB Edition	4.0	5.1	5.5	V
External Rail 6 Current		0.0	-	1.2	A
IO1 Voltage		-13.2		13.2	V
IO2 Voltage		-13.2		13.2	V
IO3 Voltage		-0.3	3.3	3.5	V
IO4 Voltage		-0.3	3.3	3.5	V

Table 7: Operating parameters for the USBHub3c expansion interface

Typical Performance Details

Specifications are valid at 25°C unless otherwise noted. Indoor use only.

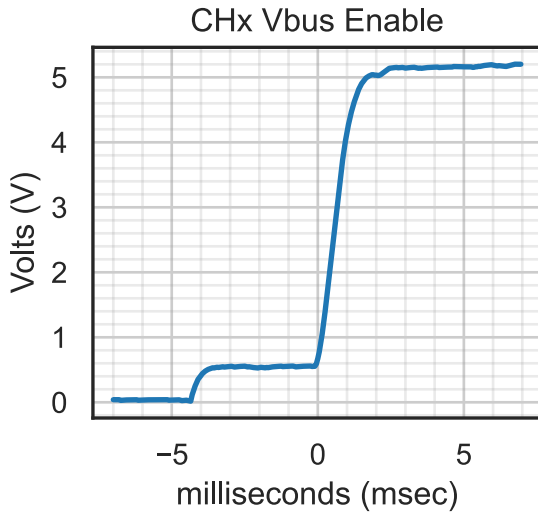

Figure 2 V_{bus} Enable to 5V Output (PRO Edition)

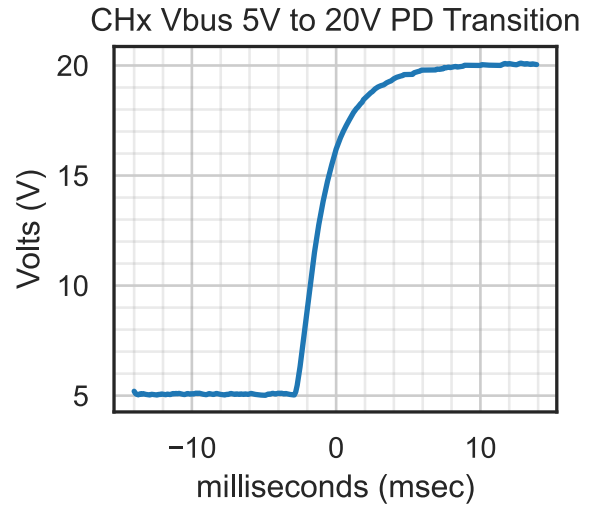

Figure 4 V_{bus} 5V to 20V Power Delivery Change (PRO Edition)

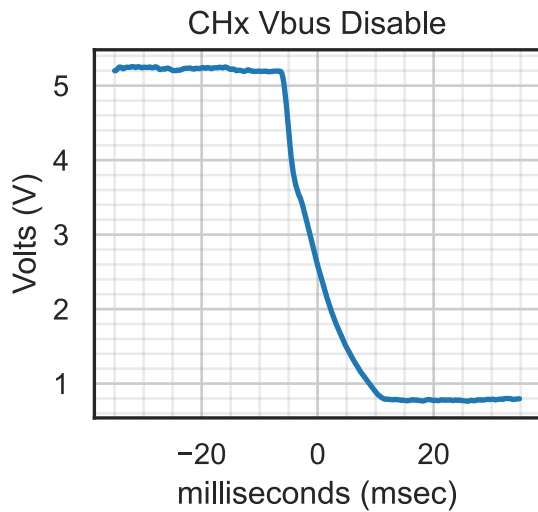

Figure 3 V_{bus} 5V Disable (PRO Edition)

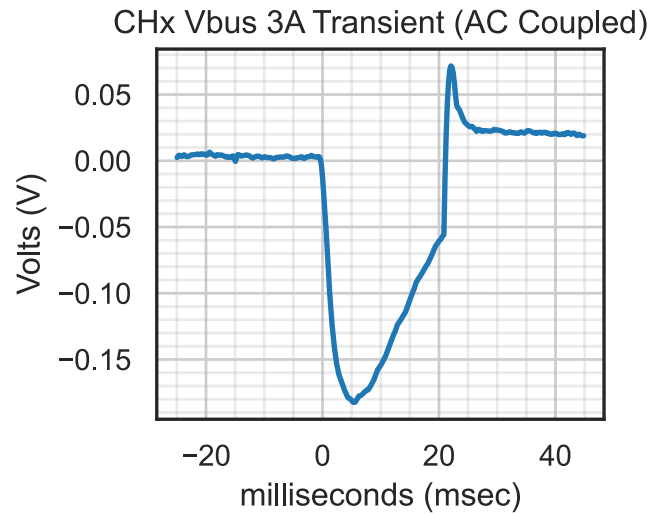

Figure 5 V_{bus} transient load at 3A (AC Coupled, PRO Edition)

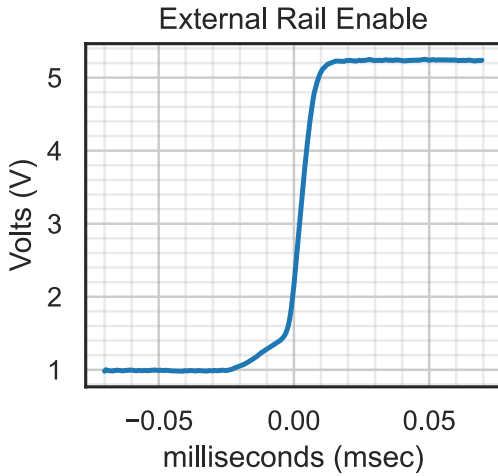

Figure 6: External Rail Enable

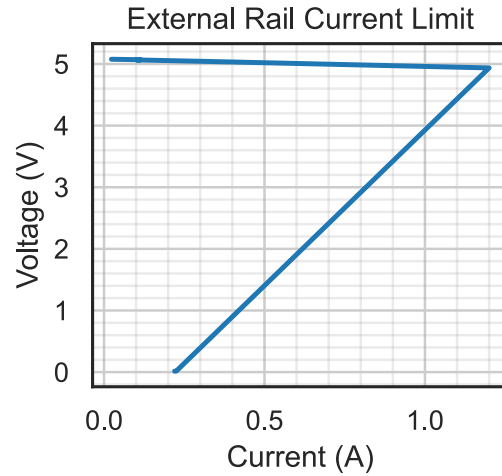

Figure 8: External Rail Current Limit

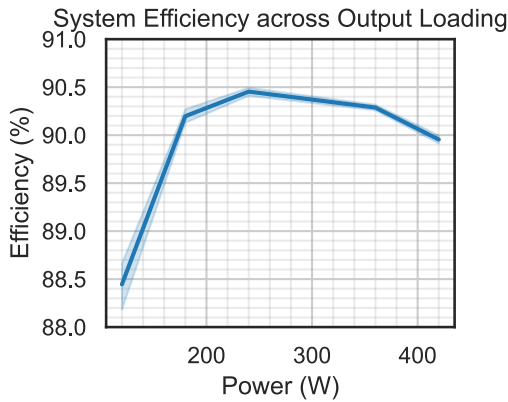

Figure 7: System Efficiency (PRO Edition)

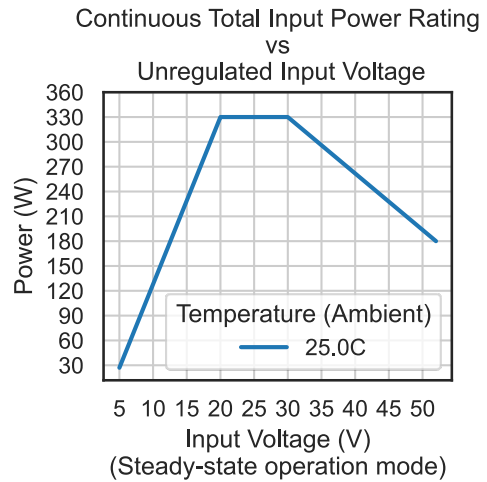

Figure 9: Power Rating vs Input Voltage (PRO Edition)

Overview

With advanced programmable control features, the USBHub3c is targeted at industrial and production systems requiring software and embedded control of USB devices. It is ideal for manufacturing test of consumer electronics and control of industrial systems.

Power Subsystem

The USBHub3c utilizes an internal switch-mode power supply system with overvoltage, undervoltage, reverse polarity, and overtemperature protection. The system can operate with high efficiency over a wide input voltage range and can draw its power from a dedicated unregulated input power connector, or any of the eight USB-C ports. Three possible system power paths are depicted in Figure 10.

Grounding

USB is sensitive to grounding and ground loops. It is important to understand your system's grounding strategy to ensure the USB shield or ground is not the primary ground current return path. The USBHub3c shorts USB shield and ground and provides an earth ground connection point. Instructions for separating shield and earth ground from USB and system ground can be obtained by contacting Acroname support.

Ground isolation methods such as optical isolators and isolated power supplies have been demonstrated to work well with the USBHub3c.

Charging Standards

There are multiple overlapping USB charging standards supported by the USBHub3c. All ports support USB Power Deliver 3.0 (PD) and are backward compatible with previous version. All USB-C connectors on the front of the device support sink and source modes. The Power-C connector (on the back of the device) only supports sink mode.

All numbered USB-C connectors support USB Battery Charge version 1.2 (BC 1.2) in standard downstream port (SDP), charging downstream port CDP, dedicated charging port (DCP) modes.

V_{bus} Power Sourcing and Sinking

The USBHub3c PRO edition features independent 100W V_{bus} supplies for each front USB-C port. The LAB edition features independent load switches for each front USB-C

port and can supply 5V at 3A on all seven ports simultaneously.

The USB-C ports 0-5 on both editions also feature switchable external V_{bus} connections for sinking up to 100W of device power to external loads. Each port features overvoltage and reverse current protection.

V_{bus} Measurement Subsystem

The USBHub3c measurement subsystem samples V_{bus} voltage and current for all seven front USB-C ports, the USB-C power input, and the input voltage.

Device Drivers

The USBHub3c leverages operating system user space interfaces that do not require custom drivers for operation on modern operating systems.

Some older operating systems may require the installation of a BrainStem USB driver to enable software control. Installation details on installing USB drivers can be found within the BrainStem Development Kit under the "drivers" folder. For example, Windows 7 requires the supplied INF to communicate with BrainStem USB devices.

Software Control

Software control of the features of the USBHub3c is performed with the BrainStem API via a BrainStem link. BrainStem links are done over USB and can be established through the selected upstream ports or the Control Port. After one or more of these ports is connected to a host machine, a user can connect to the BrainStem via software API:

```
stem.link.discoverAndConnect(USB)
```

When multiple hubs are connected to a host, connecting to a specific hub can be done by providing the hub serial number. Further, all connected hubs can be found using

```
brainstem.discover.findAllModules(USB)
```

Software Capabilities and Interfaces

The USBHub3c is built on Acroname's BrainStem system, which provides simple high-level APIs, a real-time embedded runtime engine and modular expandability. All shortened code snippets are loosely based on the C++

method calls and meant to be pseudocode. Please consult the BrainStem Reference for implementation details.⁹

USB-C Upstream and Downstream Ports

The USBHub3c has six USB USB-C ports that can be used for connections between a USB host and downstream devices. These ports are numbered 0 through 5 on the case and in software.

Any one of the six numbered ports can be selected as the upstream facing port. The other five numbered ports operate as downstream facing ports.

While it is possible to connect separate USB host devices to separate numbered USB-C ports on the USBHub3c, only one numbered port can operate as an upstream facing port. Therefore, it is not possible for multiple USB host devices to simultaneously communicate through the USBHub3c to downstream devices.

The USBHub3c defaults to using CH0 as the upstream port.

BrainStem USB-C Control Port

The USBHub3c USB-C control port carries a high-speed USB 2.0 connection to the BrainStem controller. No USB traffic can flow between the Control Port and the numbered USB-C ports. When a cable is detected in the Control Port

USB-C connector, a BrainStem link can only be established through the Control Port, regardless of the selected upstream port.

If no cable is detected in the Control Port USB-C connector, a BrainStem link can be established with a host connected to the active upstream facing port.

The Control Port provides the ability to maintain software control of the hub during the process of disconnecting and reconnecting upstream host connections to numbered USB-C ports.

Enabling and Disabling USB-C Ports

The USBHub3+ features granular control of each numbered USB-C port, including independent switches for V_{bus} , USB 2 data lines, USB 3 data lines, and CC lines.

A port can be quickly disabled or enabled with a single API call, or more discrete API calls can be used to control specific lines for a port.

Selector Switch

One click switches to next defined upstream port connection as defined in the API.

⁹ See BrainStem software API reference at <https://acroname.com/reference/> for further details about all BrainStem API methods and information.

Power Paths

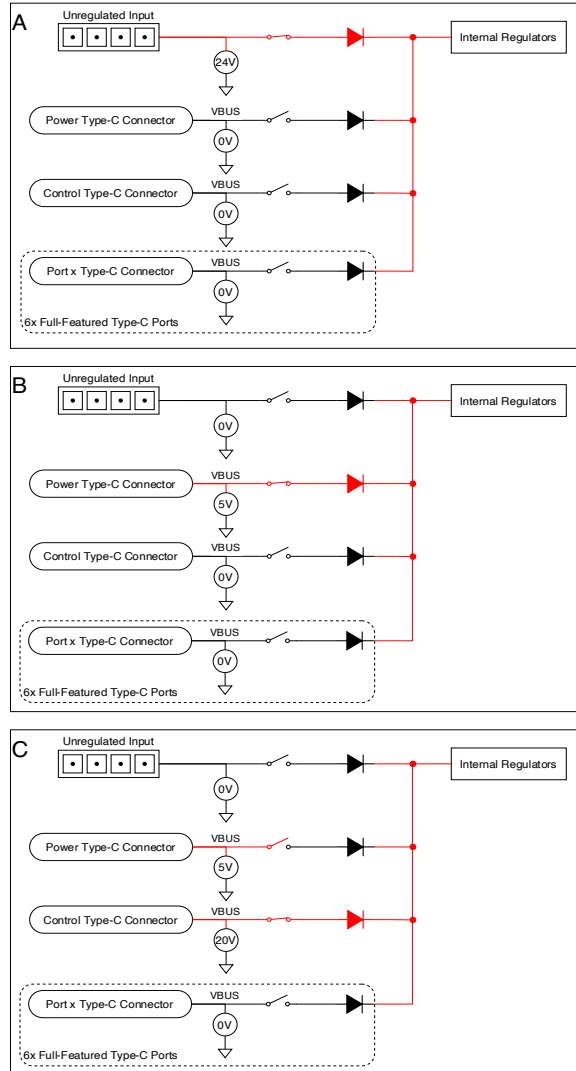

Figure 10 USBHub3c Internal Power Paths

Connection Interfaces and Indicators

Front Panel

USB-C Connectors

The front of the USBHub3c features seven USB-C receptables. The leftmost connector is a dedicated control port for communication between a computer and the USBHub3c. The other six connectors are full-featured hub ports.

Front Panel LEDs

The front of the USBHub3c has a set of connectors and LEDs to indicate control information and connectivity status. The meaning and location of each connector and LED are described in the following tables and diagrams.

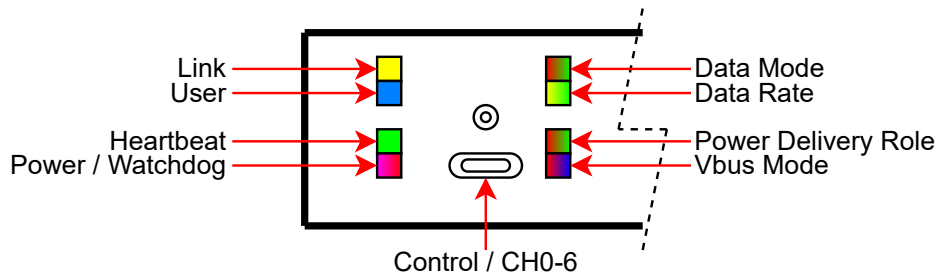

Figure 11: Front Panel Interface

LED Name	Color	Description
Link Status LED	Yellow	On once a host device has enumerated the BrainStem controller
User LED	Blue	Can be manipulated through any of the available APIs
Heartbeat LED	Green	Indicates active BrainStem connection; pulses at a rate determined by the system heartbeat rate
Power/Watchdog LED	Red Magenta	Solid red indicates the system is powered. Alternating between red and magenta is indication the internal watchdog is running and the USBHub3c firmware is healthy.
Data Mode	Green Red White	Port mode for data: green for Upstream (UFP) port, red for Downstream (DFP) port, white for Control port.
Data Rate	Yellow Green Blue	USB enumeration speed: blue for SuperSpeed+, green for SuperSpeed; yellow for Hi-Speed or lower USB 2.0 speeds.
Power Delivery Role	Red Green Blue	Power Delivery role: solid red when USBHub3c acting as Source (pulsing when unconnected), solid green when USBHub3c acting as Sink (pulsing when unconnected), blue when USBHub3c configured as Dual Role Port (Source or Sink) until negation with attached device
V _{bus} Mode	Red Blue Green White	V _{bus} operational mode: red for BC1.2, blue for Power Delivery, green for Quick Charge, white for Programmable Power Supply.

Table 8: LED indicators

Rear Panel

The back of the USBHub3c have a set of connectors for powering and extending functionality. The meaning and location of each connector are described in the following tables and diagrams.

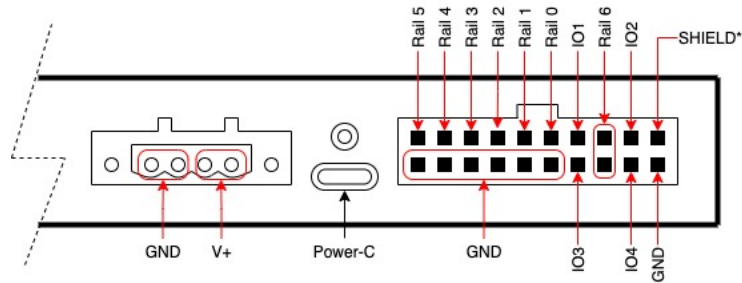

Figure 12: Back Panel Interface

Input Power Connectors

The USBHub3c can be powered in multiple ways: bus powered from power delivery negotiation on any USB-C port or a 5.08mm terminal block. A Euro-style 4-pin terminal block (“Euroblock”), is also provided by Acroname for providing DC input power. Replacement part by Phoenix Contact # 1912207. From left to right, the pins GND, GND, V+ and V+.

Dimensional drawing

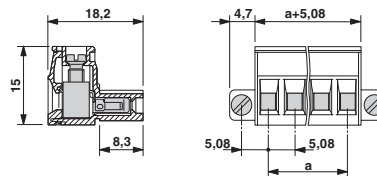

Figure 13: Euro-style 4-pin terminal block

A Power-C input power supply can serve as the power source for the system. A 100W power delivery source is recommended for power through this input interface.

Select Jack

The select jack is a 2.5mm mono audio jack. This interface allows for customizable hardware control of the hub. By default, momentary closures of the select circuit cycle the active upstream through ports 0 through 5, one port per click.

Expansion Connector

The USBHub3c expansion connector is a 20-pin, 2-row, shrouded male header block with 100mil pitch. This interface provides additional mechanisms for expandability and tests scenarios. Rail 6 is a current-limited fixed 5V source. Rails 0-5 provide access to V_{bus} for USB-C ports 0-5. All rails (0-6) are under software control but are normally disabled. Refer to Table 9 for the connector pinout.

Connection Name	Pin Number	Description
Rail 0	9	CH0 V_{bus} switched connection (Normally Open)
Rail 1	11	CH1 V_{bus} switched connection (Normally Open)
Rail 2	13	CH2 V_{bus} switched connection (Normally Open)
Rail 3	15	CH3 V_{bus} switched connection (Normally Open)
Rail 4	17	CH4 V_{bus} switched connection (Normally Open)
Rail 5	19	CH5 V_{bus} switched connection (Normally Open)
Rail 6	5, 6	Current limited 5V source
IO1	7	RS232 Serial Receive (data to USBHub3c)
IO2	3	RS232 Serial Transmit (data from USBHub3c)
IO3	8	I2C SDA
IO4	4	I2C SCL
GND	2,10,12,14,16,18,20	Ground
Shield	1 ¹⁰	Shield

Table 9: Expansion Connector Pinout

¹⁰ GND and Shield are connected internally with 0Ω resistor at the expansion connector interface. Contact Acroname for inquiries into isolation means between the two.

Mechanical

Dimensions are shown in inches [mm]. 3D CAD models available from <https://acroname.com>.

Figure 14: USBHub3c Mechanical Drawing

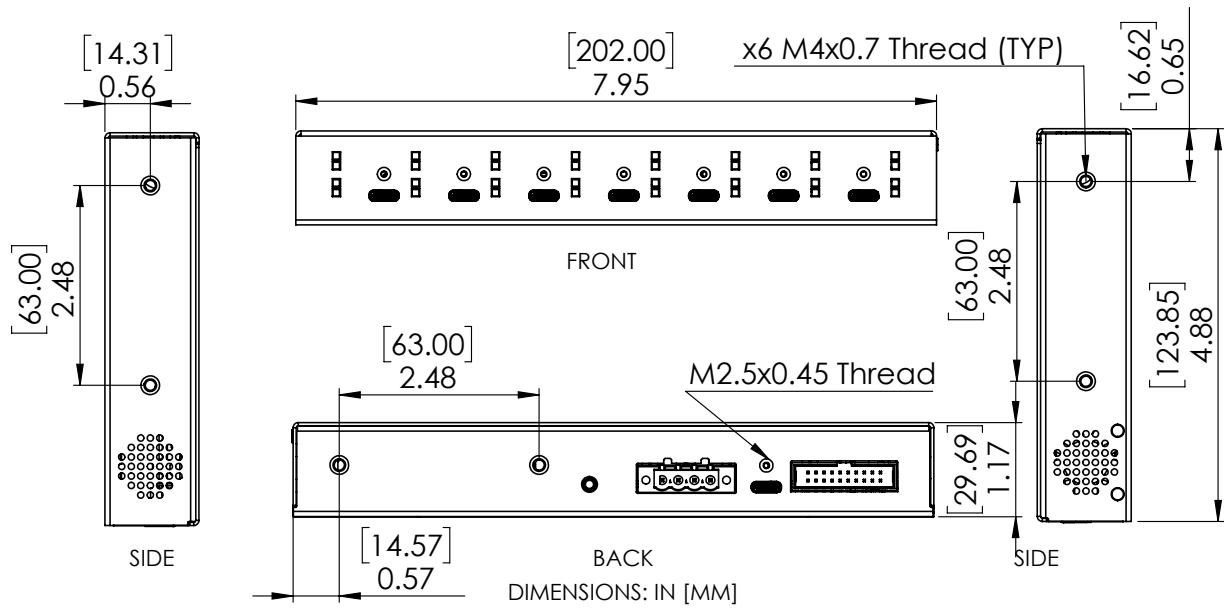

DIN Rail Mounting

DIN rail mounting provisions have been designed into the USBHub3c case. Holes for a DIN rail clip/adaptor are provided to allow mounting of the USB3c hub to standard DIN rails. Mounting clip hardware is available separately in a kit from Acroname: part number C56-DINM-1. The diagrams below illustrate USBHub3c mounted in two orientations:

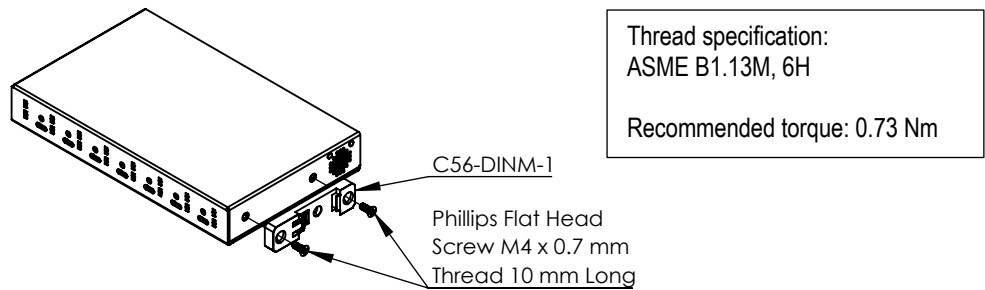

Figure 15: USBHub3c DIN Rail Mount

Markings





Symbol	Description
-	V _{supply} Negative Return connected internally to GND.
+	V _{supply} Positive Input.
	Shield / chassis terminal ¹⁰
	GND return.
	DC line voltage
	Hot parts! Burned fingers when handling the parts. Wait one-half hour after switching off before handling parts. ¹¹
	Reference datasheet for details on product operation and specifications.

Table 10: Case Symbol Markings

Application Notes

USB-C Connectivity

In general, USB-C connectors are fully functional when inserted in either orientation. However, standard USB-C cables are not symmetric, and the orientation of each USB-C cable is very important in several USBHub3c applications.

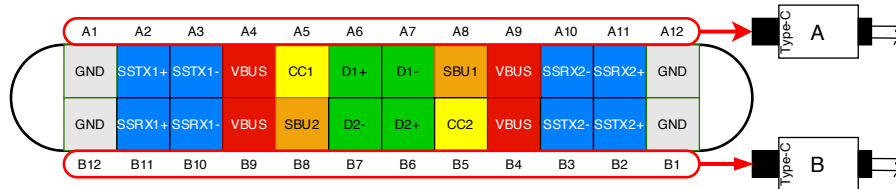

Figure 16: USB-C Connector Detail

- Figure 16 illustrates which CC line is used for Power Delivery negotiation in subsequent application notes and diagrams that specify orientation. For example, diagrams showing connectors with “A” use CC1 for PD communication.
- The CC pin (CC1 or CC2) in the receptacle that is not used for PD communication may instead be used to carry V_{conn} to power additional components once a connection is established between the host and device.
- Standard USB-C cables only include the D+ and D- data lines on the A side of the cable. To overcome the limitations this imposes, Acroname offers a Universal Orientation Cable (UOC) with both D± pairs and employs it in several applications.

The USB-C receptacle is specified for up to 20 V and 5 A. The higher rating of the receptacle enables systems to deliver or receive much more power than USB Type-A or Type-B receptacles.

¹¹ Warning: For Emergency Shutdown ensure all power sources (USB-C Ports and V_{supply}) are disconnected from the unit.

USB-C Device Communication Testing with Flips

The purpose of this application is to test that a USB-C device properly functions using both cable orientations. The USBHub3c enables orientation flips without physically removing and replacing a cable. This application focuses on USB data communication between the device and a host.

The device under test (DUT) is connected to the USBHub3c as a downstream device. A computer serves as a USB host and test station controller. A standard USB-C cable connects the USBHub3c to the host computer, while an Acroname UOC connects the DUT to the USBHub3c. The standard cable is inserted with the "A" side of the cable facing upwards. The host computer cable is connected to the USBHub3c on CH0 and the DUT on CH1, as shown in Figure 17.

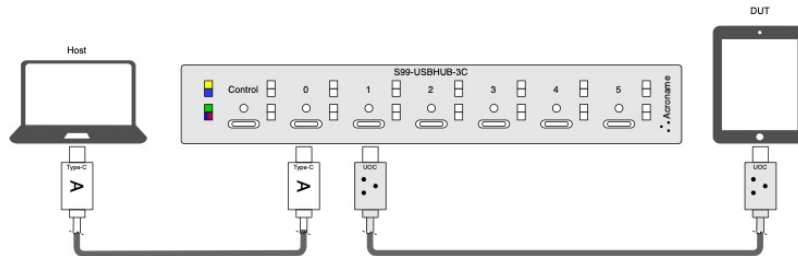

Figure 17: DUT with UOC

The Acroname UOC does not determine orientation like a standard USB-C cable, but the USBHub3c can force orientation.

DUT Side A

To test DUT Side A, the test station connects to the USBHub3c and disables CC2 on CH1. The communication between the host and the USBHub3c occurs via CH0, and the command to disable CC2 can be issued either via the graphical user interface or by software API call. Disabling CC2 on CH1 forces the DUT to use CC1 for PD negotiation, D1± for USB 2.0 data, and SSRX1±/SSTX1± for USB 3 data, as shown in Figure 18.

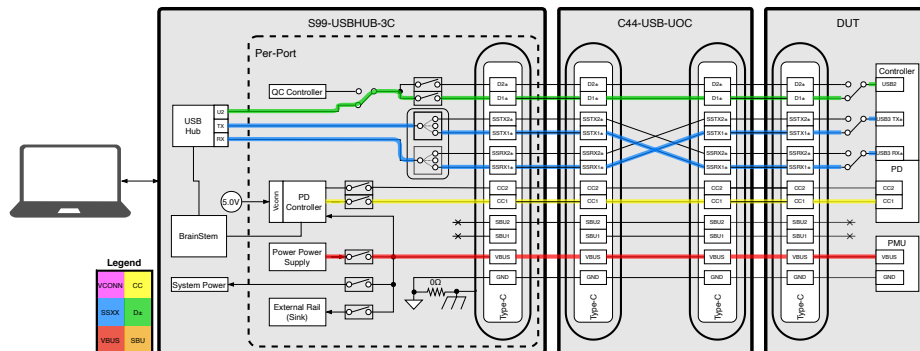

Figure 18: DUT Side A Testing

DUT Side B

To test DUT Side B, the test station disables CC1 and re-enables CC2 on CH1. Disabling CC1 on CH1 forces the DUT to use CC2 for PD negotiation, D2± for USB 2.0 data, and SSRX2±/SSTX2± for USB 3 data, as shown in Figure 19.

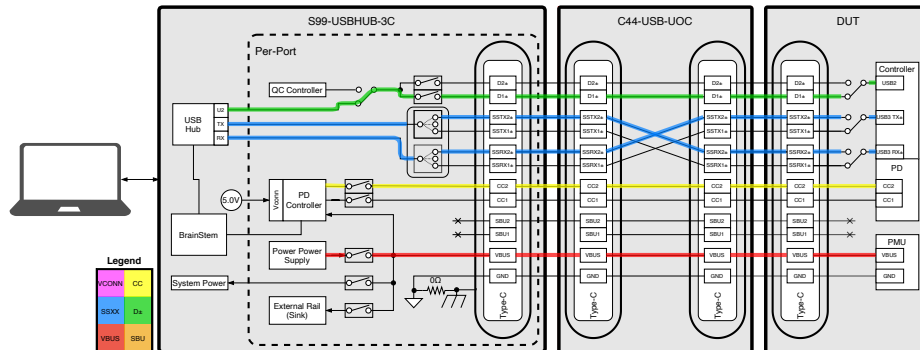

Figure 19: DUT Side B Testing

DUT USB 2

USB downstream devices normally attempt to enumerate as USB 3 devices by default, and only fallback to USB 2 if USB 3 is unavailable or fails. To test DUT USB 2 functionality, the test station disables the USB 3 SuperSpeed (SS \pm) data lines on CH1. As with CC, the test station can disable data lines connections via software control. With SS \pm disabled, the DUT can only communicate with the host via the USB 2 High Speed (D \pm) data lines. The test station can use tools on the computer itself to verify that the DUT is properly communicating using USB 2. This should be completed during both Side A and Side B testing.

DUT USB 3

To test DUT USB 3 functionality, the test station re-enables SS \pm , and possibly disables D \pm . Again, the test station can use tools on the computer itself to verify USB 3 communications with the DUT, for both DUT Side A and Side B.

Test Coverage

By using the USBHub3c to complete USB 2 and USB 3 testing on DUT Side A and Side B, all the USB data lines and both CC lines in the USB-C receptacle have been tested with one cable insertion.

USB-C Device Power Delivery Tests

The purpose of this application is to test that a USB-C device probably sources or sinks power according to power delivery negotiations. The example DUT can either source and sink power, as would be the case with a laptop that can use a USB-C port for charging and peripheral connections.

The DUT is connected to the USBHub3c using an Acroname UOC to CH1. To ensure maximum test coverage, the UOC is rated for 5 A. The test station is connected to CH0 using a standard USB-C Cable. See Figure 17 for connections. As with USB communication testing, the UOC enables one DUT insertion to test both CC lines for successful Power Delivery negotiations.

DUT as Sink PD Rule Negotiation

To test DUT as Sink PD Rule Negotiation, the test station configures USBHub3c CH1 to only act as a source of V_{bus}. This results in a pull-down resistor getting connected to CC, which the DUT should detect. With the PRO edition, the test station can also enable or disable specific PD source rules that are advertised to the DUT. The test station will observe the result of PD negotiations between the USBHub3c and the DUT, as well as collect voltage and current measurements of the V_{bus} current for CH1. The USBHub3c will detect and flag negotiation errors and overcurrent conditions. To expand coverage, one CC line can be disabled to force PD negotiations to occur on the other CC line.

DUT as Source Rule Negotiation

To test DUT as Source PD Rule Negotiation, the test station configures USBHub3c CH1 to only act as a sink of V_{bus}. This results in a pull-up resistor getting connected to CC, which the DUT should detect. The test station can also select specific PD source rules that the USBHub3c requests from the DUT. The USBHub3c will collect V_{bus} measurements and detect errors, all of which will be observed by the test station.

DUT as Source V_{bus} Loading

The USBHub3c features the ability to connect an external load to each port's V_{bus} . While the USBHub3c can sink its own power from connected PD devices that source V_{bus} , a fully programmable electronic load provides more complete test coverage. In this scenario, the external load is connected to the Rail1 pin of the expansion connector on the rear of the USBHub3c, as shown in Figure 20. The test station configures the USBHub3c to enable Rail1, resulting in CH1 V_{bus} passing through the USBHub3c to the external load. The test station configures the external load to sink power according to the test requirements. The V_{bus} current measurements from the USBHub3c for CH1 include the current flowing through the external load.

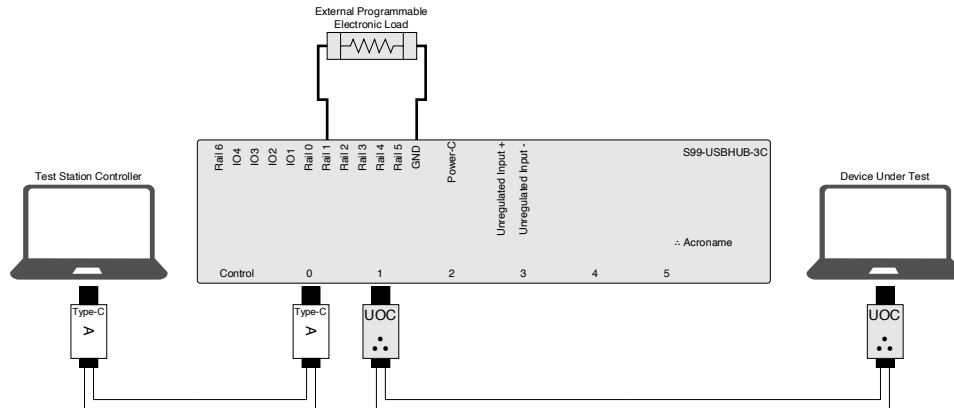

Figure 20: DUT with External Load

Test Coverage

By using the USBHub3c to complete DUT PD testing, both source and sink capabilities are tested up to 100W¹² in either direction, including PD rule negotiation on each CC line, measurements of V_{bus} , and detection of rule violations. All testing is conducted in a single DUT insertion, which can also include USB data functional testing, as noted in the preceding application note.

¹² The LAB edition can only source 15W, but can still sink 100W.

FCC Compliance Statement

This equipment has been tested and found to comply with the limits for a Class B digital device, pursuant to part 15 of the FCC Rules. These limits are designed to provide reasonable protection against harmful interference in a residential installation. This equipment generates, uses and can radiate radio frequency energy and, if not installed and used in accordance with the instructions, may cause harmful interference to radio communications. However, there is no guarantee that interference will not occur in a particular installation. If this equipment does cause harmful interference to radio or television reception, which can be determined by turning the equipment off and on, the user is encouraged to try to correct the interference by one or more of the following measures:

- Reorient or relocate the receiving antenna.
- Increase the separation between the equipment and receiver.
- Connect the equipment into an outlet on a circuit different from that to which the receiver is connected.
- Consult the dealer or an experienced radio/TV technician for help.

This device complies with part 15 of FCC Rules. Operation is subject to the following two conditions; (1) This device may not cause harmful interference, and (2) this device must accept any interference received, including interference that may cause undesired operation.

Compliance Information

ACRONAME
S99-USBHUB-3C-PRO, S99-USBHUB-3C-LAB
USB-C Hub with Power Delivery Analyzer + Tester
Input: PRO: 6VDC - 48VDC, 500W
LAB: 6VDC - 48VDC, 100W
Output: PRO: 5VDC - 20VDC, 100W
LAB: 5VDC, 15W
Country of Origin: United States of America



ACRONAME
S99-USBHUB-3C-PRO, S99-USBHUB-3C-LAB
產品名稱: USB-C集線器帶供電分析儀 + 測試儀USB-C Hub with Power Delivery Analyzer + Tester

	LAB	PRO
Input 輸入	Rated Power/額定輸入 100W	500W
	Rated Voltage/額定電壓 6-48V	6-48V
Output 輸出	Rated Power/額定輸入 15W	100W
	Rated Voltage/額定電壓 5V	5-20V

Country of Origin: United States of America



警告使用者:
此為甲類資訊技術設備, 於居住環境中使用時, 可能會造成射頻擾動, 在此種情況下, 使用者會被要求採取某些適當的對策。

D98795
RoHS

International Identifications:

Country	Identification
China	產品名稱: USB-C集線器帶供電分析儀 + 測試儀

Class A Warning

(Warnings must be marked in Traditional Chinese)

甲類警語

警告使用者:此為甲類資訊技術設備, 於居住環境中使用時, 可能會造成射頻擾動, 在此種情況下, 使用者會被要求採取某些適當的對策。

この装置は、クラスA 機器です。この装置を住宅環境で使用すると電波妨害を引き起こすことがあります。この場合には使用者が適切な対策を講ずるよう要求されることがあります。
VCCI-A

Equipment Name 型號(型式): S99-USBHUB-3C-PRO, S99-USBHUB-3C-LAB 產品名稱: USB-C集線器帶供電分析儀 + 測試儀						
Type designation (Type) 限用物質及其化學符號 Restricted substances and its chemical symbols						
單元Unit	鉛Lead (Pb)	汞Mercury (Hg)	鎘Cadmium (Cd)	六價鉻Hexavalent chromium (Cr ^{VI})	多溴聯苯Polybrominated biphenyls (PBB)	多溴二苯醚Polybrominated diphenyl ethers (PBDE)
機殼 Chassis	○	○	○	○	○	○
電路板 PCB Board	○	○	○	○	○	○
連接器 Connector	○	○	○	○	○	○
電子元件 Electronic Component	○	○	○	○	○	○

備考1. "超出0.1 wt %" 及 "超出0.01 wt %" 係指限用物質之百分比含量超出百分比含量基準值。
Note 1. "Exceeding 0.1 wt %" and "exceeding 0.01 wt %" indicate that the percentage content of the restricted substance exceeds the reference percentage value of presence condition.
備考2. "○" 係指該項限用物質之百分比含量未超出百分比含量基準值。
Note 2. "○" indicates that the percentage content of the restricted substance does not exceed the percentage of reference value of presence.
備考3. "—" 係指該項限用物質為排除項目。
Note 3. The "-" indicates that the restricted substance corresponds to the exemption.

Product Support

Questions about the product operation or specifications are welcome through Acroname's contact portals. Software downloads, reference API and application examples are available online at:

<https://acroname.com/support>

Direct communication and additional technical support are available at:

<https://acroname.com/contact-us>

2741 Mapleton Avenue

Boulder, CO, USA 80304-3837

720-564-0373 (phone)

Document Revision History

All major documentation changes will be marked with a dated revision code

Revision	Date	Engineer	Description
1.0	June 2021	ACRO	Initial Revision
1.1	Nov 2021	FEC	Correct titles, captions; add over voltage and altitude specifications
1.2	Nov 2021	TDH	Remove references to S99-USBHUB-3C-LAB
1.3	Dec 2021	GCF	Update Sampling Frequency
1.4	Feb 2022	MJK	Change to input vs output power rating
1.5	Mar 2022	MJK	Added hot warning label information into Markings Table
1.6	Mar 2022	CWG	Update LED Behavior
1.7	June 2022	MJK	Continuous output power rating plot update
1.8	July 2022	MJK	Mechanical drawing updates
1.9	July 2022	GCF	Added additional warnings and power supply notes
1.10	Aug 2022	GCF	Update DIN rail part number
1.11	Oct 2022	TDH	Add PRO and LAB Edition distinctions
1.12	Feb 2023	MJK	Updated product image to match other documentation
1.13	May 2023	MJK	Added Taiwan safety compliance statement. Adjusted absolute input current on Lab per safety compliance testing. Update to document description. Added V_{bus} voltage and current setpoint specifications.
1.14	July 2023	MJK	Included Chinese name, BSMI compliance information
1.15	September 2023	MJK	BSMI RoHS table updates
1.16	May 2024	MJK	VCCI warning instructions