



The SF02/F is a lightweight laser rangefinder module that provides fast and accurate distance measurements.

The module comprises all the necessary optical and electronic components along with embedded software for a pulsed laser, time-of-flight, distance measuring instrument.

Its configurable features and standard hardware interfaces make the SF02/F an easy to understand module that can be used in unmanned aerial vehicles (UAV), radio-controlled aircraft and robots.

Digital and analog interface ports make the SF02/F the ideal module for experimenters.

Features:

- *A laser-based rangefinder module suitable for many applications.*
- *Accurately measures the distance to natural surfaces and objects.*
- *Can detect surfaces and objects up to a distance of 50 meters, even in bright sunlight.*
- *Measures distance at 32 readings per second.*
- *Includes digital and analog interfaces with programmable capabilities.*
- *Easy to configure using the built-in menus and LightWare Terminal software.*
- *Fully calibrated and ready to run.*
- *Affordable for the student or hobbyist.*
- *Robust and reliable.*
- *Not affected by: wind; changes in barometric pressure; noise; ambient light; terrain or air temperature.*

Table of contents

Product ordering codes 2
 1. Overview 3
 2. Quick start guide 4
 3. Making connections to the SF02/F..... 5
 4. Menu options 10
 5. Instructions for safe use 14
 Appendix A :: Specifications..... 15
 Appendix B :: Accuracy profile..... 15
 Appendix C :: Dimensions..... 16
 Appendix D :: SF02/F Arduino shield (SF02-AS) 16
 Revision history..... 17

Table of figures

Figure 1 :: The main features of the SF02/F 3
 Figure 2 :: Power from the USB port 5
 Figure 3 :: Battery power 5
 Figure 4 :: Regulated 5 V DC supply 5
 Figure 5 :: Dual redundant power supplies..... 6
 Figure 6 :: USB communications 7
 Figure 7 :: Analog interface, Analog voltage output..... 7
 Figure 8 :: Digital interface, Digital alarm output 7
 Figure 9 :: Alarm indicator LEDs 8
 Figure 10 :: Serial interface, Auxiliary serial port basic connection 8
 Figure 11 :: Serial interface, Auxiliary serial port with hardware trigger 8
 Figure 12 :: Digital expansion port 9
 Figure 13 :: Analog expansion port 9
 Figure 14 :: LightWare Terminal showing menu options..... 9
 Figure 15 :: Compensating for the height of the landing gear..... 11
 Figure 16 :: Data smoothing..... 11
 Figure 17 :: Height above ground represented by the analog voltage output..... 12
 Figure 18 :: Ground proximity alarm warning 13
 Figure 19 :: Labelling on the SF02/F..... 14
 Figure 20 :: Accuracy profile 15
 Figure 21 :: Dimension drawings of the SF02/F 16
 Figure 22 :: SF02/F with SF02/F Arduino shield (SF02-AS) attached 16
 Figure 23 :: SF02/F Arduino shield (SF02-AS) kit of parts 16



Product ordering codes

Model family	Model name	Model description
SF02	SF02/F (50 m)	Rangefinder, max 50 m

Disclaimer

Information found in this document is used entirely at the reader’s own risk and whilst every effort has been made to ensure its validity neither LightWare Optoelectronics (Pty) Ltd nor its representatives make any warranties with respect the accuracy of the information contained herein.

1. Overview

The lightweight, SF02/F laser rangefinder module is an essential addition to any system that needs fast, accurate and reliable distance measurements.

Operating from a 9 V battery or a regulated 5 V DC supply, the SF02/F includes analog, digital and serial interfaces that can be easily connected to an embedded controller or a standard processing platform such as Arduino® or Raspberry Pi®. Each interface on the SF02/F can be configured using a simple software menu that is accessible through the built-in USB port.

The SF02/F works by measuring the time it takes for a very short flash of laser light to travel to an object and back again. The accuracy of the measurement is not affected by the color of the object's surface or the angle of incidence of the laser beam to the surface. The SF02/F is virtually immune to background light, wind, noise and other environmental interference.

The maximum measuring range of the SF02/F is 50 meters and readings are updated 32 times per second. There is an option to smooth the distance measurements if higher resolution is required or use the raw results if higher speed is needed.

In addition to the easy-to-use USB and screw terminal interfaces, there are two expansion ports which allow for alternative access to additional digital and analog signals within the SF02/F. The SF02/F can also be connected to a standard Arduino Uno compatible host controller with an SF02/F Arduino shield.

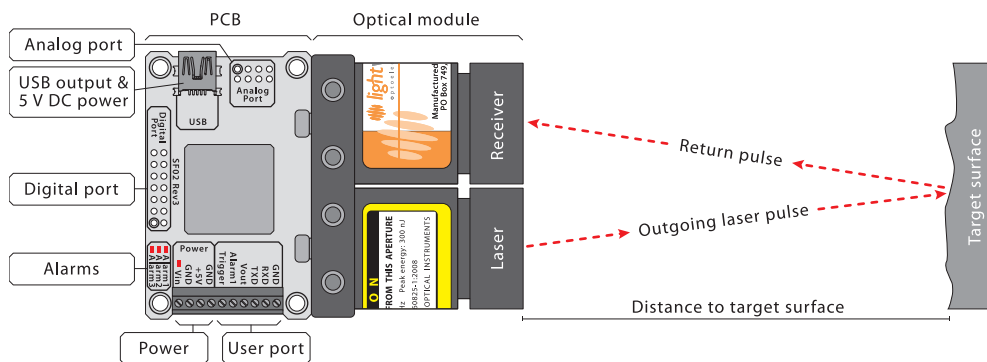
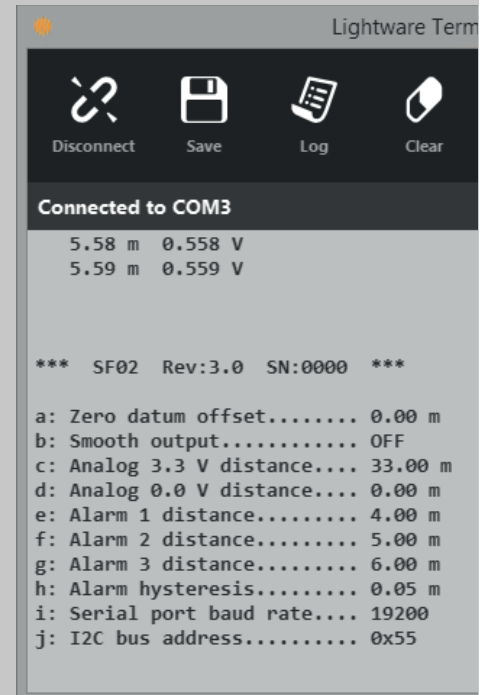

Figure 1 :: The main features of the SF02/F

2. Quick start guide

1. CAUTION - The SF02/F laser rangefinder contains a laser and should never be aimed at a person or an animal. Do not look at the beam directly with optical instruments.
2. Plug a USB cable into the SF02's mini USB connector and connect the other end into a PC. This provides both power and communication for the unit.
3. Download *LightWare Terminal* software from www.lightware.co.za > [Library](#) > [Documents](#) > [Software](#) onto your PC. Open the installer package and follow the installation instructions. Everything needed for communicating with SF30 will automatically be installed.
4. Start the *LightWare Terminal* software and click the "Connect / Disconnect" icon to open a communications port. The distance measurements should begin to scroll in the Terminal window. If the connection isn't made automatically then click the "Laser" icon and select the correct port from the list shown.
5. The configuration menu is accessed by pressing the <SPACE> bar on your keyboard. This stops the measurements and displays a list of settings along with a brief description of what each one does. To modify a setting, type the letter displayed beside the item in the menu. Pressing the <SPACE> bar again restarts measuring.
6. A summary of the settings is given below:



Section	Setting	Range of values	Description
Zero calibration	a: Zero datum offset	-10.00m to +10.00m	Adjusts the point from which measurements are taken
Data smoothing	b: Smooth output	ON or OFF	Switches on a filter to smooth the distance readings
Analog voltage output	c: Analog 3.3 V distance	0.00m to 50.00m	Sets the distance at which the voltage output will show 3.3V
	d: Analog 0.0 V distance	0.00m to 50.00m	Sets the distance at which the voltage output will show 0.0V
Alarms	e: Alarm 1 distance	0.00m to 50.00m	Sets the distance at which the first alarm activates
	f: Alarm 2 distance	0.00m to 50.00m	Sets the distance at which the second alarm activates (available on the digital expansion port only)
	g: Alarm 3 distance	0.00m to 50.00m	Sets the distance at which the third alarm activates (available on the digital expansion port only)
	h: Alarm hysteresis	0.00m to 5.00m	Creates a deadband between the on and off points of the alarms
Auxiliary UART	i: Serial port baud rate	4800 ... 115200	Selects the baud rate of the auxiliary serial port UART channel
Auxiliary bus	j: I2C bus address	0 ... FF	Sets the auxiliary I2C address (available on the digital expansion port only)

7. Once you have confirmed your settings, make sure the SF30 is measuring correctly then click the "Disconnect" icon and disconnect the USB cable from the SF02/F.
8. There are several power supply and interface options available. These connections are used to integrate the SF02/F into your system and details of all the options are explained later in this document.

3. Making connections to the SF02/F

The SF02/F has four power supply options and a number of digital and analog interfaces. Only one power supply needs to be connected for correct operation and any one, or more, of the interfaces may be connected to a host controller.

Power supply option 1: USB power

The first option is to power the unit directly from the USB port of a PC or laptop. This is particularly useful for testing the SF02/F before it is installed in your system and also for changing the settings in readiness for the final application.

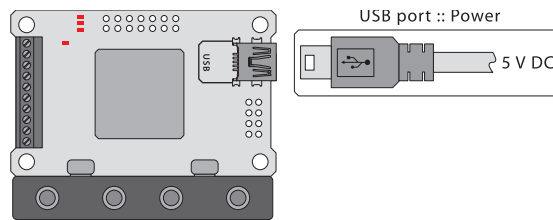

Figure 2 :: Power from the USB port

Power supply option 2: Unregulated power

The second power supply option is to connect to an unregulated power supply or battery with a voltage of 6.5 - 9 V DC between “Vin” and “GND” on the screw terminals. In this configuration a regulated 4.7 V DC power output becomes available on the “+5 V” screw terminal and this can be used by external circuitry as a source of regulated power. The unregulated power connections can also be accessed via the Digital expansion port, see page 9 for further information.

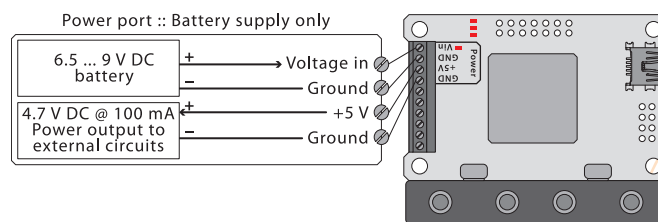

Figure 3 :: Battery power

Power supply option 3: Regulated power

The third power supply option is to use a regulated 5 V supply connected between the “+5 V” and “GND” screw terminals. In this configuration the “Vin” terminal is not used. The 5 V DC supply would typically be taken from an existing power rail that is used to supply other electronic equipment. The regulated power connections can also be accessed via the Digital expansion port, see page 9 for further information.

CAUTION: The 5 V power input is not protected from reverse polarity. Damage to the SF02/F will result if this connection is reversed.

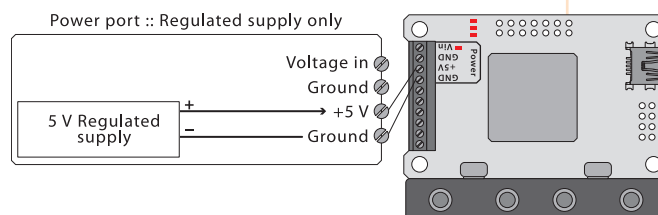

Figure 4 :: Regulated 5 V DC supply

Power supply option 4: Dual redundancy

For high reliability applications, dual redundancy of the power supply can be achieved by connecting both an unregulated 9 V supply and a regulated 5 V supply. In this configuration, the 5 V must be supplied through a reverse protection diode with a low forward voltage drop. We recommend using a 1N5819 Schottky diode. Under normal conditions power is drawn from the 5 V supply but if this supply fails then power will be drawn from the unregulated supply. The dual redundancy power connections can also be accessed via the Digital expansion port, see page 9 for further information.

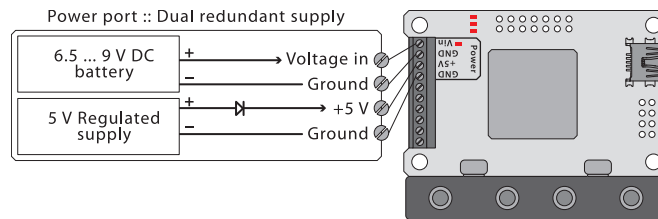

Figure 5 :: Dual redundant power supplies

USB port

The SF02/F has a mini USB interface that can be used to communicate with *LightWare Terminal* software on a PC. This connection also provides power to the unit making it quick and easy to test and configure the SF02/F. The associated virtual serial port transmits at 115200 baud with 1 stop bit and no parity or handshaking. More details are discussed in the “Menu options” section below.

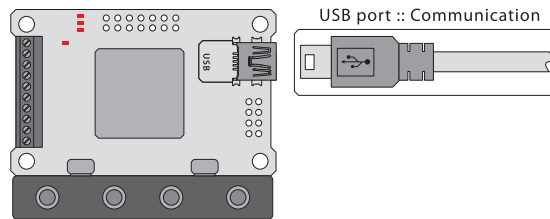

Figure 6 :: USB communications

Analog voltage output

The analog voltage interface on the “Vout” screw terminal produces a linear voltage of between 0.0 V and 3.3 V that is proportional to the measured distance. The actual distances of the 0.0 V and 3.3 V end points can be adjusted through the menu system. The analog voltage can be measured by the host controller using any available analog-to-digital-converter (ADC). The voltage is updated 32 times per second and has 10 bit resolution.

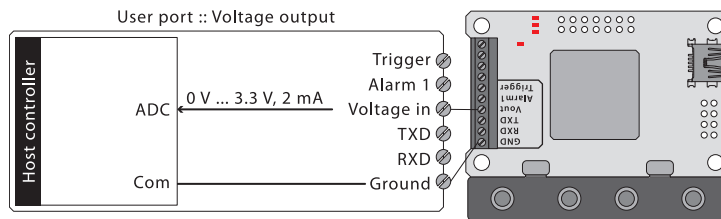

Figure 7 :: Analog interface, Analog voltage output

Alarm outputs

The alarm output on the “Alarm1” screw terminal is a digital warning signal that becomes active when an object is closer than a preset distance. The alarm distance can be set using the menu system. The alarm is active high with an output of 3.3 V. This alarm signal can be connected to an available digital port pin on the host controller and read as: low = safe and high = alarm.

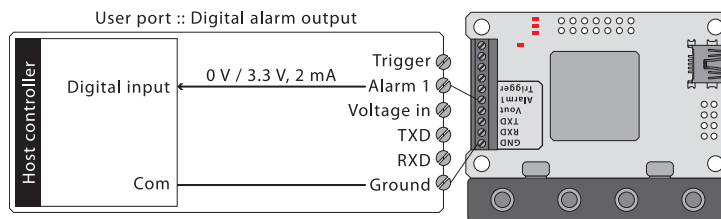

Figure 8 :: Digital interface, Digital alarm output

There are two additional alarms available on the digital expansion port (see “Digital expansion port” on page 9) and all three alarms give a visible LED indication when active.

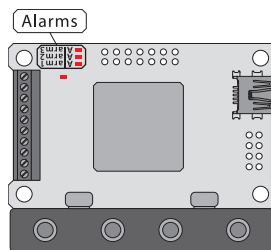

Figure 9 :: Alarm indicator LEDs

Auxiliary serial port

The auxiliary serial port on the “TXD” and “RXD” screw terminals transmits an ASCII encoded string as a floating point representation of the distance measured. The serial port uses 0 V / 3.3 V logic and is designed for direct connection to a similar serial port on the host controller. The baud rate is selectable using the menu system.

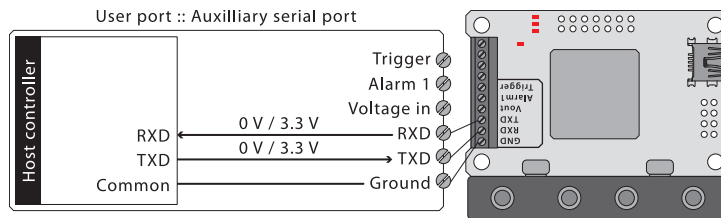

Figure 10 :: Serial interface, Auxiliary serial port basic connection

The time when distance data is transmitted from the auxiliary serial port is controlled by one of two triggers. The first is a software trigger provided by the host controller through its serial port and consists of the ASCII code for the letter <D>. When the SF02/F receives this character it outputs the next available distance result which will happen in less than 30 ms.

There is an alternative hardware trigger on the “Trigger” screw terminal that can be controlled by a digital port pin on the host controller. This trigger must be a negative going pulse, and must return to 3.3 V before the next result is transmitted from the auxiliary serial port.

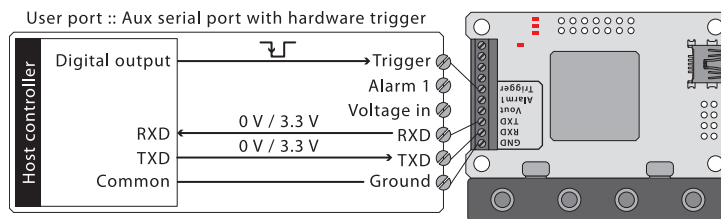
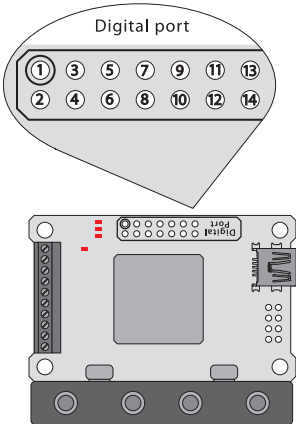

Figure 11 :: Serial interface, auxiliary serial port with hardware trigger

Digital expansion port

The digital expansion port has an unpopulated, 0.1" pitch header that gives access to all the features available on the screw terminals plus 2 additional alarms and an I2C bus.



1	Voltage in	Unregulated power input, 6.5V .. 9.0V
2	Alarm 3	0 V / 3.3 V logic level alarm number 3
3	Ground	Ground
4	Alarm 2	0 V / 3.3 V logic level alarm number 2
5	+ 5 V	+5 V power input or output
6	Alarm 1	0 V / 3.3 V logic level alarm number 1
7	Do not connect	This pin must be left unconnected
8	Trigger	Trigger input
9	SCL	Clock line for I2C bus
10	Voltage out	Analog voltage output 0 V ... 3.3 V logic levels
11	SDA	Data line for I2C bus
12	TXD	Serial transmit using 0 V / 3.3 V logic levels
13	Ground	Ground
14	RXD	Serial receive using 0 V / 3.3 V logic levels

Figure 12 :: Digital expansion port

Analog expansion port

A analog expansion port is available to advanced users who want to see the outgoing laser pulses and the return signal on an oscilloscope or convert them into digital data using ADCs. This port has an unpopulated, 0.1" pitch header. Note that connections to these port pins may affect the accuracy of the readings due to noise picked up from the connecting wires.

The signals on the analog port are on a much slower time-base than the actual laser pulses which travel at the speed of light. The process of converting the fast signals into slower representations is called "sequential-equivalent-time-sampling" or SETS.

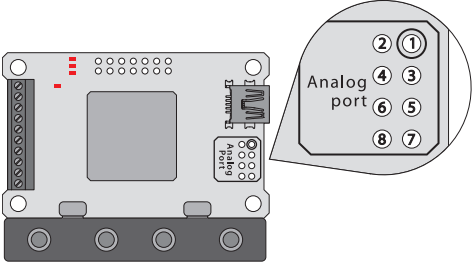

1	Signal	An inverted, analog image of the return signal. The maximum amplitude is 2.6V with a period of 31.25 ms
2	Ground	Ground
3	Zero	An analog image of the outgoing laser pulse. The maximum amplitude is 2.6V with a period of 31.25 ms
4	Ground	Ground
5	Timer-sync	A 32 Hz square-wave that can be used to trigger an oscilloscope or synchronize ADC conversion cycles
6	Ground	Ground
7	ADC-sync	A 32 kHz square wave that can be used to trigger ADC conversions
8	Ground	Ground

Figure 13 :: Analog expansion port

4. Menu options

The SF02/F can be connected through the on-board USB port to a Terminal emulation program running on a PC. LightWare provides a free Terminal program available for download from its website at www.lightware.co.za > Library > Documents > Software

Once the USB connection is made, the Terminal window displays the distance reading from the SF02/F. Pressing the <SPACE> bar stops the measuring process and changes the display to a menu that lists all the available settings and configuration options. Pressing the <SPACE> bar again restarts the measuring process.

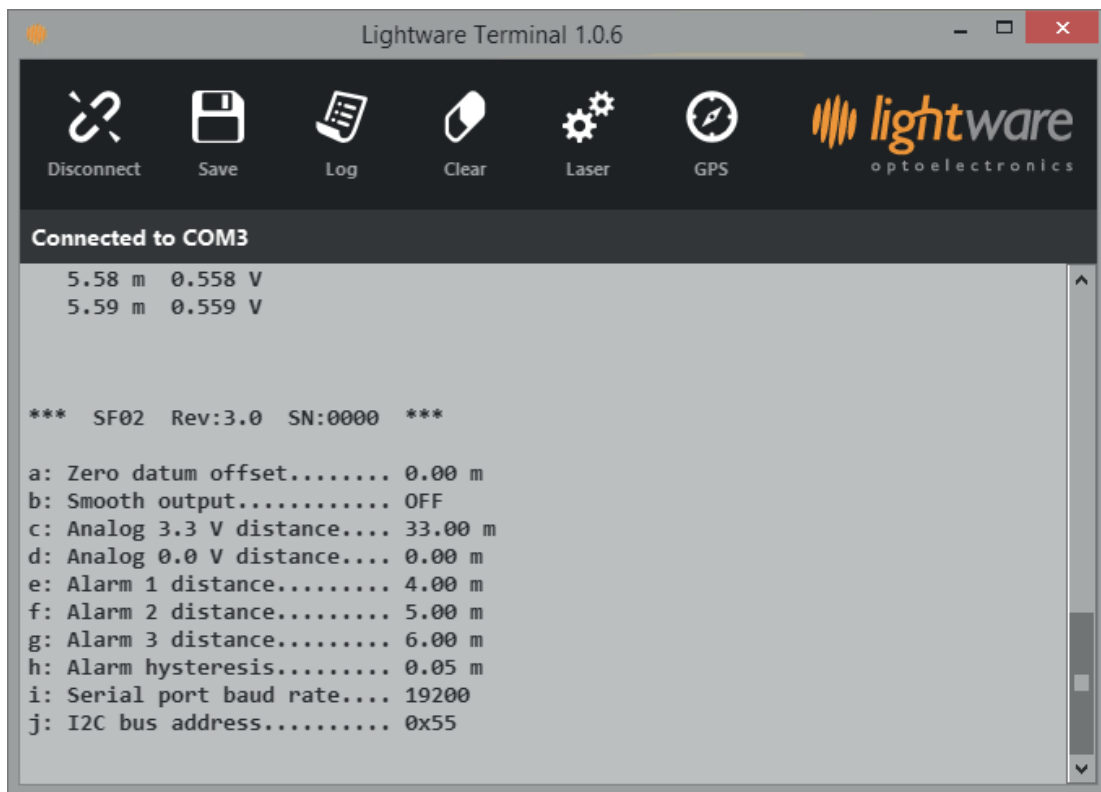

Figure 14 :: LightWare Terminal showing menu options

Zero calibration

a: Zero datum offset (-10.00m to +10.00m) - Adjusts the point from which measurements are taken

The point from which distance measurements are taken can be adjusted using menu item <a>. The range of values that can be entered are from -10.00 meters to +10.00 meters. This zero point adjustment can be used to compensate for the mounting position of the SF02/F in the final system, where distance readings may best be interpreted from a suitable point on the system rather than from the front face of the SF02/F.

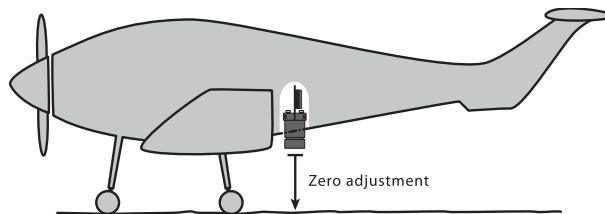

Figure 15 :: Compensating for the height of the landing gear

Data smoothing

b: Smooth output (ON or OFF) - Switches on a filter to smooth the distance readings

Data smoothing can be selected by menu item to be either ON or OFF. The distance always updates at 32 readings per second, however, the filter will provide a smoother result on uneven surfaces as well as remove the occasional “out of range” signals if they are present.

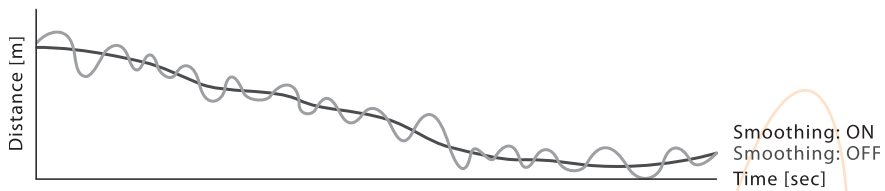

Figure 16 :: Data smoothing

Analog voltage output

- c: Analog 3.3 V distance (0.00m to 50.00m) - Sets the distance at which the voltage output will show 3.3 V*
- d: Analog 0.0 V distance (0.00m to 50.00m) - Sets the distance at which the voltage output will show 0.0 V*

Menu items <c> and <d> relate to the analog voltage output and are used to set the end point distances that correspond to the 0.0 V and 3.3 V output voltages. These voltages are read by the ADC of the host controller and can be converted back into a distance by using the formula:

$$d = v / 3.3 * (DH - DL) + DL$$

where:

d = measured distance

v = voltage measured by the ADC of the host

DL = 0.0V distance

DH = 3.3V distance

The range of values for both distance settings is from 0.00 meters to 50.00 meters. The analog voltage output updates at 32 readings per second and has a 10 bit resolution.

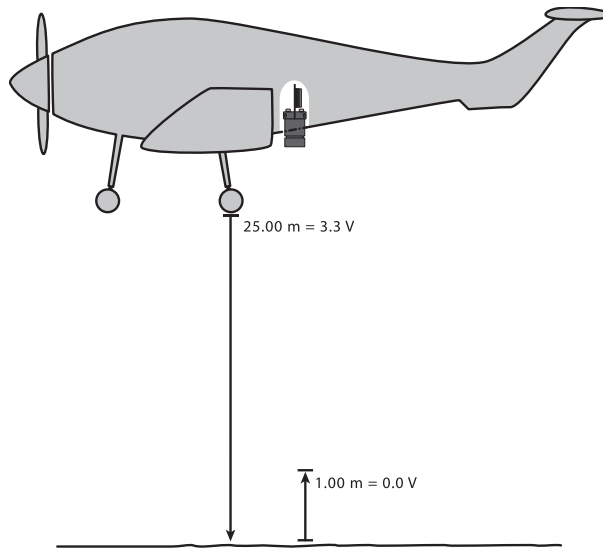

Figure 17 :: Height above ground represented by the analog voltage output

Alarms

- e: Alarm 1 distance (0.00m to 50.00m)** - Sets the distance at which the first alarm activates
- f: Alarm 2 distance (0.00m to 50.00m)** - Sets the distance at which the second alarm activates (available on the digital expansion port only)
- g: Alarm 3 distance (0.00m to 50.00m)** - Sets the distance at which the third alarm activates (available on the digital expansion port only)
- h: Alarm hysteresis (0.00m to 1.00m)** - Creates a dead-band between the on and off points of the alarms

A digital alarm output goes high whenever an object is detected that is closer than the distance setting shown in menu items <e>, <f> and <g>. This distance can be set from 0.00 meters to 50.00 meters and each alarm output is updated 32 times per second. To prevent multiple switching of the alarm output, menu item <h> provides for hysteresis on the alarm distances. This will change the alarm activation and deactivation distances to:

$$\begin{aligned} \text{activation distance} &= \text{alarm distance} - \text{hysteresis} \\ \text{deactivation distance} &= \text{alarm distance} + \text{hysteresis} \end{aligned}$$

The hysteresis can be adjusted up to ± 5.00 meters.

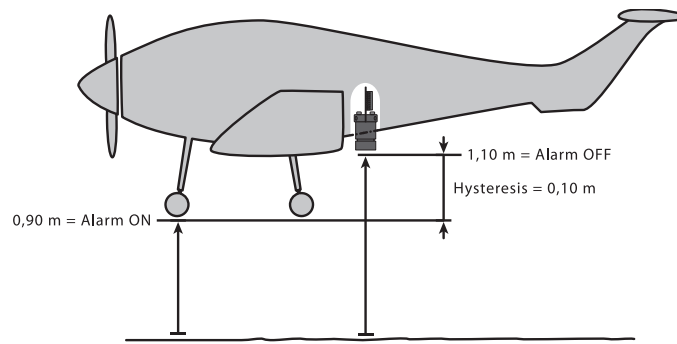

Figure 18 :: Ground proximity alarm warning

Auxiliary UART

- i: Serial port baud rate (4800 ... 115200)** - Selects the baud rate of the auxiliary serial port UART channel

The auxiliary serial port, or UART, transmits a serial string of ASCII encoded data from the SF02/F to the host controller. The baud rate of transmission is selected by menu item <i> and can be any of the standard baud rates from 4800 to 115200. By default, there is one stop bit and no parity or handshaking on this serial port.

The ASCII string representing the distance is in fixed point format with two decimal places followed by carriage return and line feed, as follows:

```
"22.48\r\n"
```

where carriage return and line feed are given by the hexadecimal ASCII characters:

```
\r = 0x0D
\n = 0x0A
```

Data is sent out of the auxiliary serial port whenever a "trigger" notification is received. The ASCII character <D> acts as a trigger when transmitted by the host controller to the SF02/F. Additionally, there is a falling edge, hardware trigger that can be controlled by a digital port pin on the host controller.

Auxiliary bus port (I2C)

- j: I2C bus address (0 ... FF)** - Sets the auxiliary I2C address (available on the digital expansion port only)

There is an I2C bus available for systems where bus communication is used to reduce the number of ports required for communication. The address can be set using menu option <j> and the maximum latency is 60 ms.

The host controller acts as the I2C "master" and sends the address to the SF02/F as an 8 bit value (7 address bits plus 1 read bit). The SF02/F then returns the distance as a 16 bit integer, formatted as high byte followed by low byte in centimetres.

5. Instructions for safe use

The SF02/F is a laser range finder that emits ionizing laser radiation. The level of the laser emission is Class 1M which indicates that the laser beam is safe to look at with the unaided eye but must not be viewed using binoculars or other optical devices at a distance of less than 15 meters. Notwithstanding the safety rating, avoid looking into the beam and switch the unit off when working in the area.

CAUTION -- The use of optical instruments with this product will increase eye hazard.

The SF02/F should not be disassembled or modified in any way. The laser eye safety rating depends on the mechanical integrity of the optics and electronics so if these are damaged do not continue using the SF02/F. There are no user serviceable parts and maintenance or repair must only be carried out by the manufacturer or a qualified service agent.

No regular maintenance is required for the SF02/F but if the lenses start to collect dust then they may be wiped with suitable lens cleaning materials. Make sure that the SF02/F is switched OFF before looking into the lenses.

The SF02/F should be mounted using the four holes provided in the circuit board. Do not hold or clamp the lens tubes as this may cause damage and adversely affect the laser safety rating.

Laser radiation information and labels

Specification	Value / AEL	Notes
Laser wavelength	905 nm	
Pulse width	< 20 ns	
Pulse frequency	< 36 kHz	
Peak power	< 10 W	50 mm aperture at 2 m
Average power	< 0.6 mW	7 mm aperture
Average energy per pulse	< 300 nj	
NOHD	15 m	Distance beyond which binoculars may be used safely

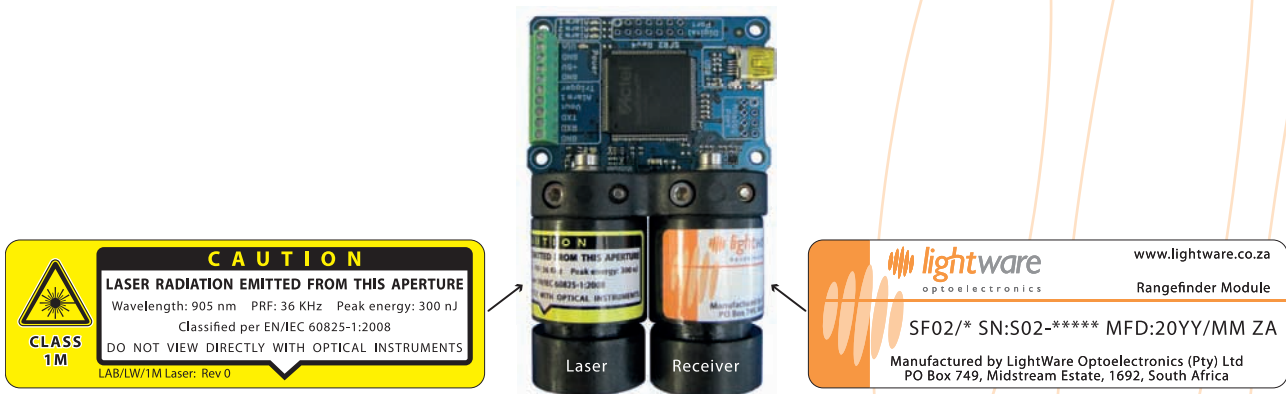

Figure 19 :: Labelling on the SF02/F

Appendix A :: Specifications

	SF02/F
Range	50 m (natural targets) indoor and outdoor use
Resolution	1 cm
Update rate	32 readings per second
Accuracy	See Figure 17 below
Power supply voltage	6.5 V .. 9.0 V or 5.0 V \pm 0.5 V DC
Power supply current	150 mA (maximum)
Outputs & interfaces	Analog, serial and digital
Dimensions	27 x 59 x 86 mm
Weight	69 g (2.43 oz)
Mounting	4 x M3 (4 x 4-40)
Connections	Screw terminal: 0.1 in. pitch header
Laser power	10 W (peak typical), 10 mW (average maximum), Class 1M
Beam divergence	0.2° (typical)
Operating temperature	0 ... 40°C
Approvals	FDA accession no.: 1630994-000 (2016/09)

Appendix B :: Accuracy profile

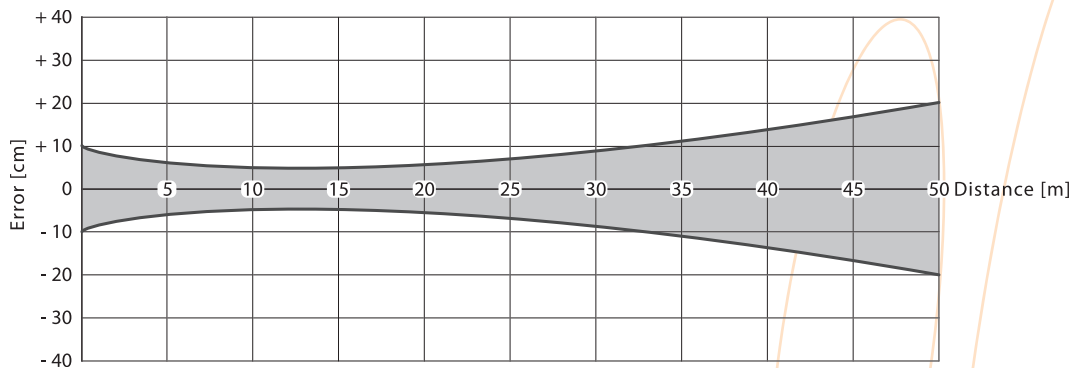

Figure 20 :: Accuracy profile

Appendix C :: Dimensions

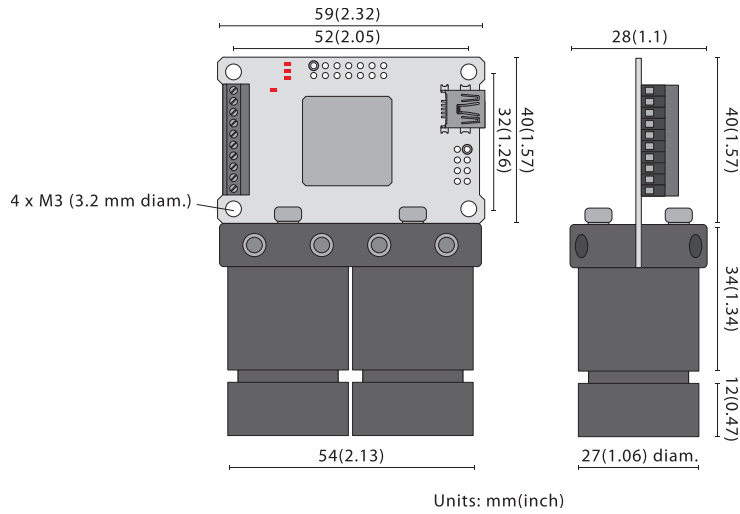

Figure 21 :: Dimension drawings of the SF02/F

Appendix D :: SF02/F Arduino shield (SF02-AS)

The SF02/F Arduino shield makes it quick and easy to connect the SF02/F to a standard Arduino Uno compatible host controller. All the pins for the digital and analog ports are passed through the SF02-AS and can be selectively connected to the Arduino port pins. An additional prototyping area with 0.1" pitch holes is also included.

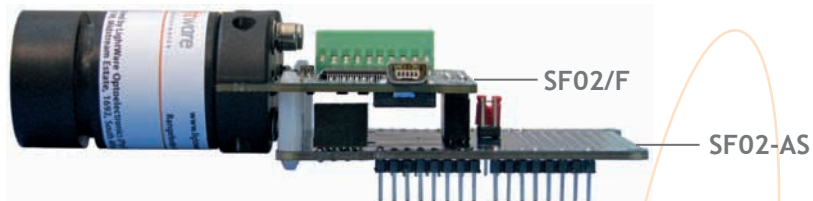

Figure 22 :: SF02/F with SF02/F Arduino shield (SF02-AS) attached

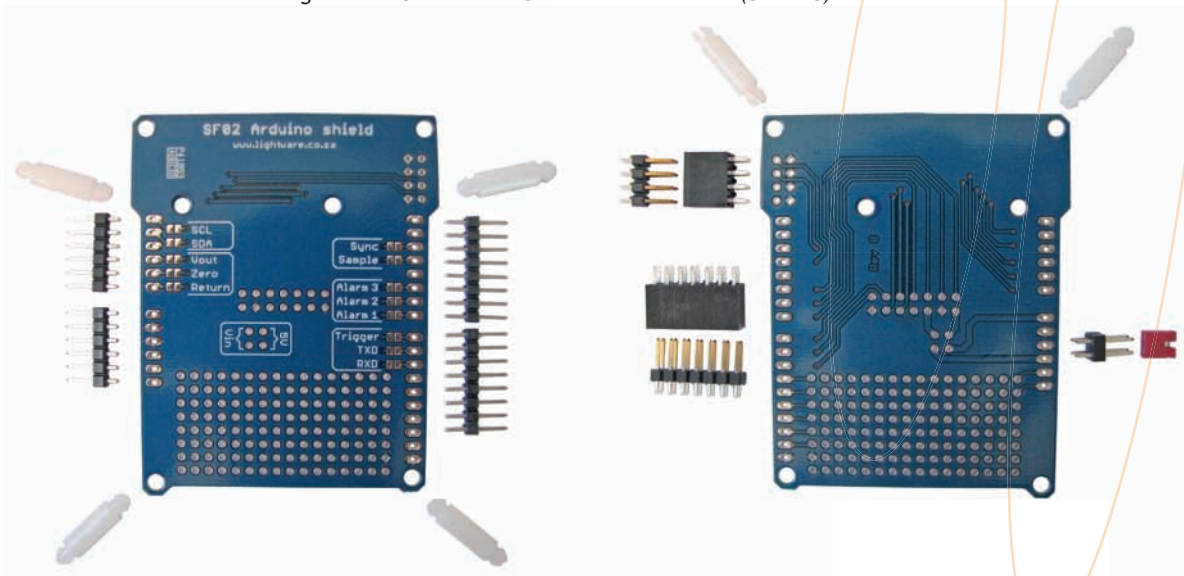

Figure 23 :: SF02/F Arduino shield (SF02-AS) kit of parts

Revision history

Version	Date	Authors	Comments
Rev 11	2016/09/14	TLP	Updated FDA accession number “1630994-000 (2016/09)” in “Appendix A :: Specifications” (page 15).
Rev 10	2016/08/08	TLP	Updated “Auxiliary bus port (I2C)” section to include “The host controller acts as the I2C “master” and sends the address to the SF02/F as an 8 bit value (7 address bits plus 1 read bit). The SF02/F then returns the altitude as a 16 bit integer, formatted as high byte followed by low byte in centimetres.” (page 13).
Rev 9	2015/08/31	TLP	Updated laser radiation information and labels to reflect values for 905 nm laser (page 14) Updated “Appendix A :: Specifications” with FDA accession no.: 1310953-001 (2015/09) (page 15).
Rev 8	2015/03/03	TLP	Updated maximum range to 50 m. Updated update rate to 32 readings per second. Update “Quick start guide” summary of settings (page 4). Updated “Figure 11 :: LightWare Terminal showing menu options” (page 9). Include “Digital expansion port” section (page 9). Include “Analog expansion port” section (page 9). Update “Figure 20 :: Accuracy profile” graph (page 15). Include “Appendix D :: SF02/F Arduino shield” (page 16).
Rev 7	2014/11/21	TLP	Updated “Appendix A :: Specifications” with FDA accession no.: 1430677-000 (2014/08) (page 13).
Rev 6	2014/02/11	TLP	Corrected: “There is an alternative hardware trigger on screw terminal <u>5</u> ” (page 8). Updated “Appendix A :: Specifications” (page 13).
Rev 5	2014/01/12	TLP	Included “SF02” module on page 1 and Appendix A :: Specifications table (page 13). Amended Appendix A :: Specifications “Dimensions” (page 13).
Rev 4	2014/01/05	JEP	Corrected the hexadecimal ASCII characters: \r = 0x0D and \n = 0x0A (page 11).
Rev 3	2013/12/18	TLP	“Appendix A :: Specifications” (page 13) include “Approvals” information regarding FDA accession number “1310953-000”
Rev 2	2013/09/30	TLP	“Appendix A :: Specifications” (page 13) corrected “Measuring range” to read “40 m”.
Rev 1	2013/09/12	TLP	Move section “1. Overview” to page 3. Include “-“ and “+” symbols in Figures 3, 4 and 5. Update UAV image in Figures 12, 13 and 15.
Rev 0	2013/09/03	JEP	First edition